

***TECHNICAL
INFORMATION***

CITIZEN QUARTZ

Cai. No. 945※※

Cai. No. 947※※

CONTENTS

§1. OUTLINE	P1
§2. FEATURES	P1
§3. SPECIFICATIONS	P2
§4. HANDLING INSTRUCTIONS	P3
§5. CIRCUIT DIAGRAM	P4
§6. DISASSEMBLY/ASSEMBLY OF MOVEMENT	P5
§7. TROUBLESHOOTING AND ADJUSTMENT	P7

§1. OUTLINE

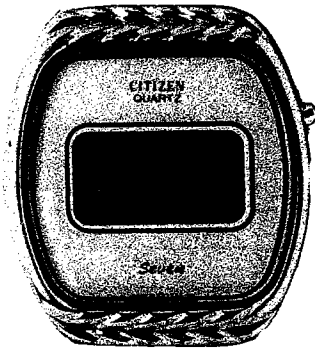

This is a digital quartz watch for ladies, featuring a thin-gage and fancy design along with a reasonable price. With addition of this new ladies' watch, the Citizen digital fashion watch group will find a larger watch of ladies.

§2. FEATURES

- 1) A simple display of the hour and minute, which can be switched to the calendar display or the second display with operation of a push-button.
- 2) The soft and rounded shapes of display characters enhances the fashionableness of the ladies' watch.
- 3) A simple operation of the watch functions is ensured by two push-buttons.
- 4) The DFC (Digital Frequency Control) method is applied.

Cal No. 947**

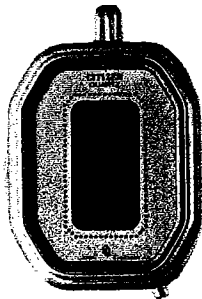

This caliber is exactly identical to Cal. No. 945** in terms of the specifications and operation except for the vertical display screen against the horizontal one.

This technical information is based mainly on Cal. No. 945**, and refer to the "External View of Cal. Nos. 945 and 947" on the following page for the difference between the display screens.

§3. SPECIFICATIONS

Caliber Nos.		9450A/B, 9470A/B
Type		Digital quartz crystal watch
Size of module (mm)		(3-9h) 18.0 x (12-6h) 14.4 x 4.35 ^t (Power cell part 4.4 ^t)
Accuracy		±20 sec./month at normal temperatures
Oscillation		32,768 Hz
Method of display		FE-twist nematic LC (Liquid Crystal), 2-split multiplex driving
Integrated circuit		C/MOS-LSI unit
Effective temperature range		±0°C ~ 55°C (32°F ~ 131°F)
Adjustment of time rate		D.F.C. method (Adjustment terminal for market available) *Measure time 10 sec.
Display functions	Time	Hour & minute
	Calendar	Month & date
	Second	Second
	*Setting time	Shown by correction digit designation mark
Additional functions		<ul style="list-style-type: none"> ● Automatic calendar (Feb. 28-day display system) ● Auto-return
Power cell (Silver oxide)		Parts No. : 280-29 1 unit Cell Code : SR721SW (Ag ₂ O/NaOH) Nominal voltage : 1.55V Capacity : 23mAH Size (mm) : 7.9φ x 2.1 ^t Lifetime : About 2 years
Others		A → Reflecting plate : Silver color B → Reflecting plate : Gold color

External View of Cal. Nos. 945 and 947

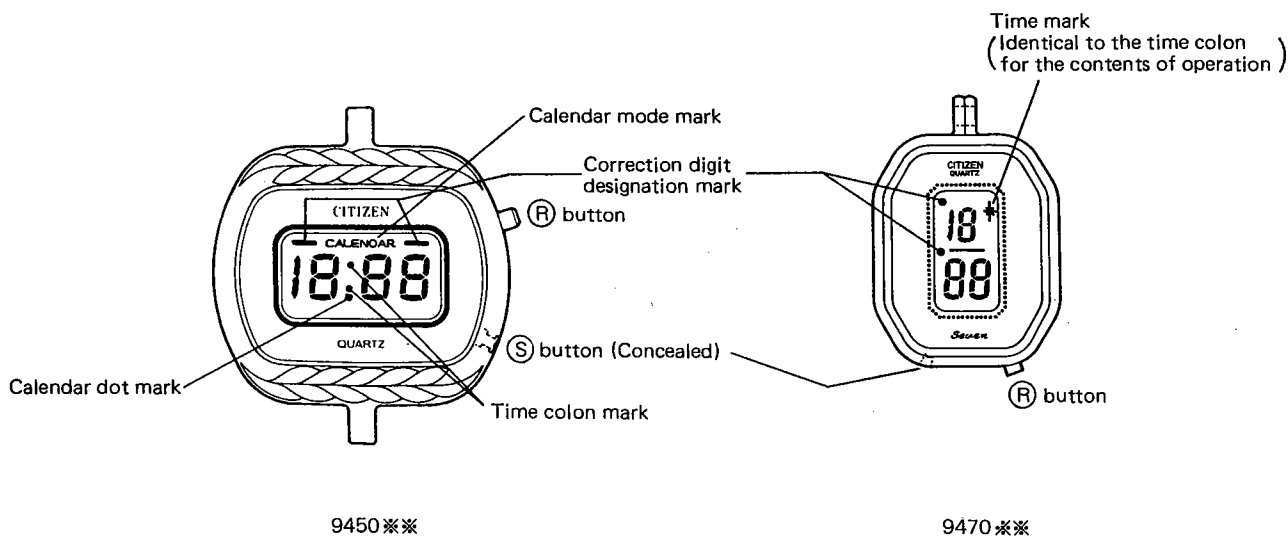

§ 4. HANDLING INSTRUCTIONS (The flashing is shown by ○.)

4-1. Switching of display

The display is changed as follows with operation of (R) button.

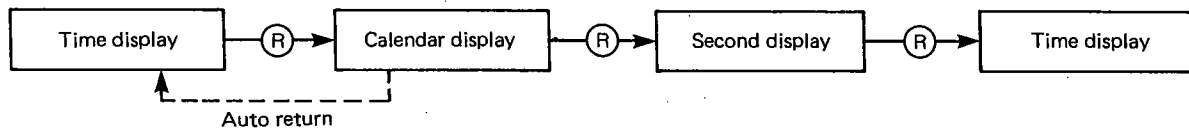

The auto-return functions in 2 ~ 3 seconds after release of (R) button.

4-2. Setting of time/calendar

With push of (S) button in the mode of the time display, the setting mode is secured. The digit of correction is indicated by the correction digit designation mark.

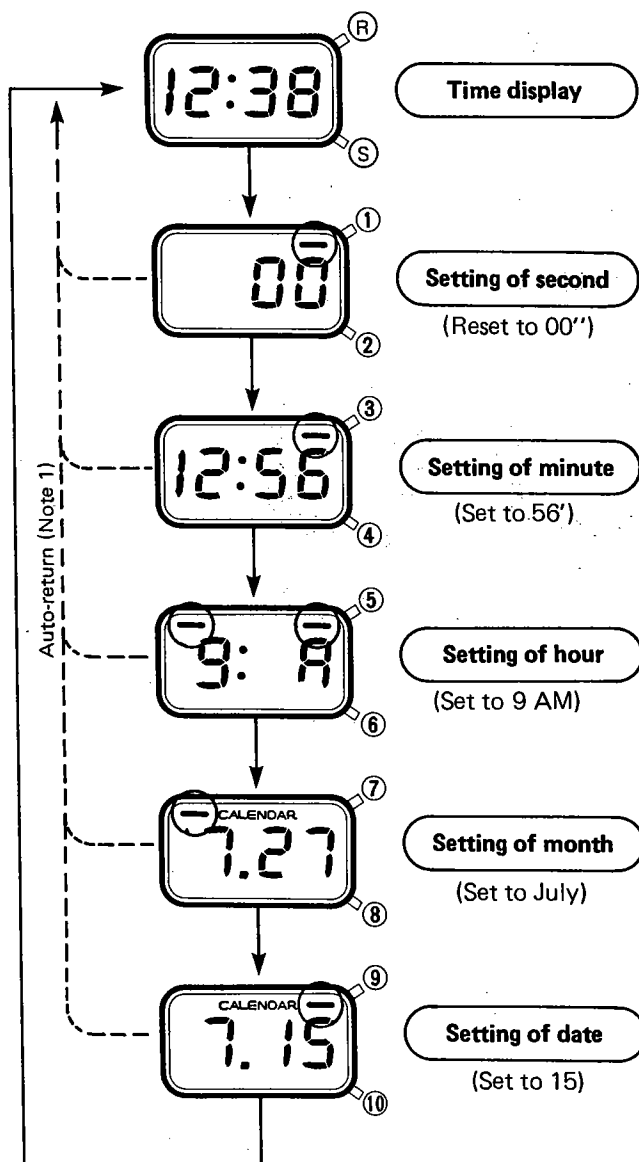

The setting mode is secured with push of (S) button.

① The resetting to 0 second is carried out with push of (R) button.

- 0-sec. reset up to 29 seconds → Omission
- 0-sec. reset at and after 30 seconds → Carry of "minute"

② The minute is corrected with (S) button.

③ The minute is set with (R) button

④ The hour is corrected with (S) button.

⑤ The hour is set with (R) button. Make sure **A** (AM) and **P** (PM).

⑥ The month is corrected with (S) button.

⑦ The month is set with (R) button.

⑧ The date is corrected with (S) button.

⑨ The date is set with (R) button. (Note. 2)

⑩ The time display is given again with (S) button.

The setting of time/calendar is over.

(Note 1) Auto-return

Any mode of display returns automatically to the time display in 1 ~ 2 minutes after push of (S) or (R) buttons.

(Note 2) Setting of day

If a non-existing date is set, the date is changed automatically to the first day of the following month.

(Ex.) Set to June 31 → July 1 displayed automatically

*In the case of a leap year, the date 29 must be set on the very February 29. This is due to the fact that February 28 jumps to March 1 since this watch applies the "February 28" system. And the "February 29" is not a non-existing date.

§5. CIRCUIT DIAGRAM

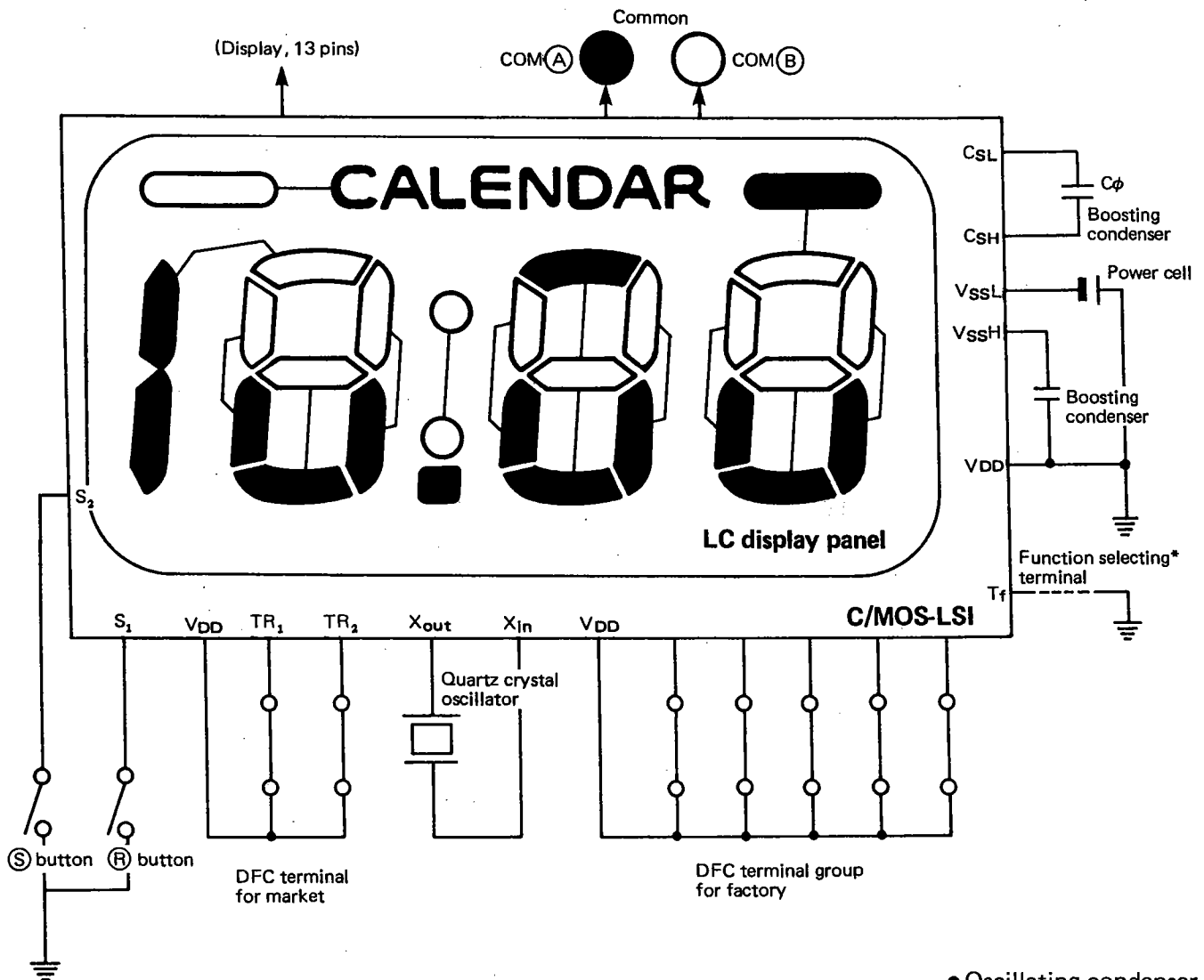

● Oscillating condenser incorporated

*Function selecting terminal (Tf)

The IC this caliber can select the use of the calendar function. And this terminal is used for this selection.

§ 6. Disassembly/Assembly of Movement

6-1. Disassembling/assembly procedure

Disassembling procedure: ① → ⑧
 Assembling procedure: ⑧ → ①

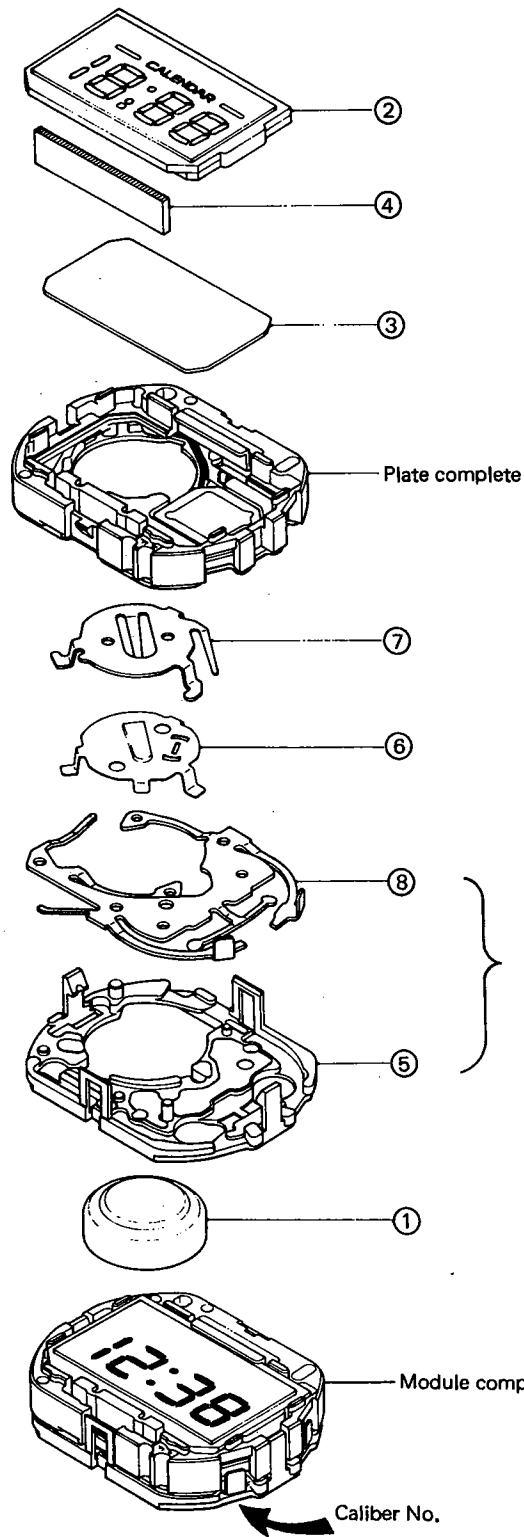

Name of parts:

- ① Power cell
- ② LC display panel
- ③ Reflecting plate
- ④ LC display panel connection rubber
- ⑤ Device cover
- ⑥ Power cell insulator sheet
- ⑦ Power cell connector
- ⑧ Supporter for plate complete

The supporter for plate complete ⑧ is set to the device cover ⑤

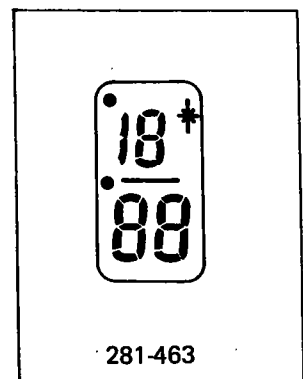

6-2. Notes on disassembly/assembly

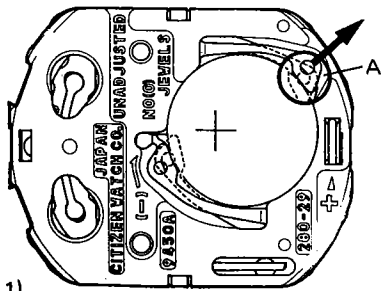

(Fig. 1)

- 1) How to remove power cell (Fig. 1)
As shown by the solid lines in Fig. 1, the power cell is held by the supporter for plate complete (II) in this caliber. When removing the power cell, the power cell holder is made to ride onto the upper surface of the power cell as shown by the dotted line in the figure. Then the part A in the figure is set free toward the direction of the arrow. In this instant, the power cell pops out.

(It does not matter if the power cell is put into the case with the power cell holder set onto the upper surface of the power cell.)

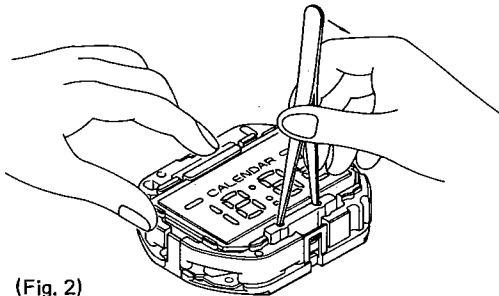

(Fig. 2)

- 2) Disassembly/assembly of LC display panel (Figs. 2 & 2')
As illustrated in Fig. 2, the hook part of the LC display panel supporter is set free with a tweezers. Then the LC display panel is removed. In this case, a meticulous care must be given not to break the electrode part of the LC display panel.

The assembly of the LC display panel is done as illustrated in Fig. 2'.

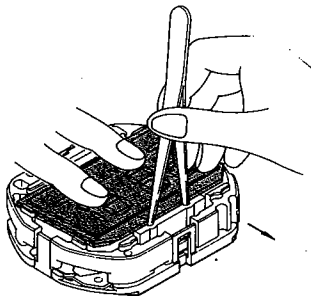

(Fig. 2')

- 3) Disassembly/assembly of device cover (Fig. 3)
The hook parts (4 areas) of the device cover to the LC display panel supporter are released. The hook parts are provided at the two areas marked by and their corresponding positions.

When assembling the device cover, a complete engagement must be confirmed between the LC display panel supporter and those hook parts mentioned above each. Avoid giving a malformation to the hook parts.

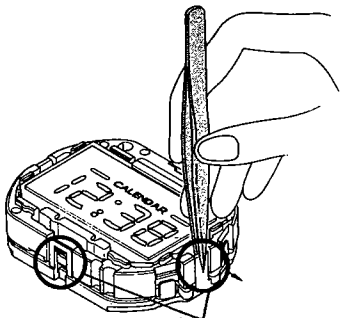

(Fig. 3)

Hook parts

- 4) How to remove supporter for plate complete (Fig. 4)
The power cell holder is set free as illustrated in Fig. 4. Then the supporter for plate complete is removed.

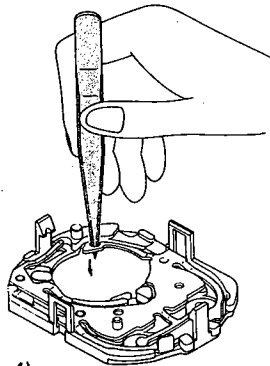

(Fig. 4)

- 5) How to set power cell connector spring (Fig. 5)
The power cell connector spring is set so that a complete contact may be secured between the "arm" (marked with Δ in Fig. 5) of the power cell connector and the VssL pattern of the plate. The VssL pattern can be seen through from the back side of the plate complete (as marked with O).

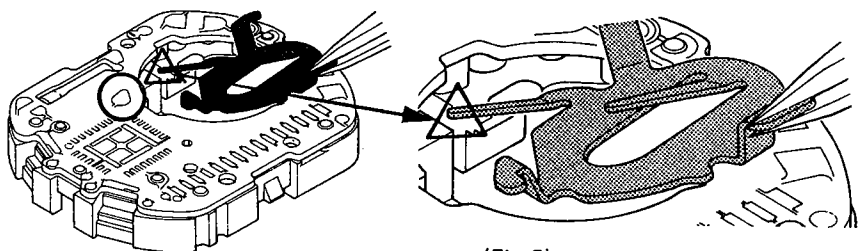

(Fig. 5)

7. TROUBLESHOOTING AND ADJUSTMENT

Flow chart of troubleshooting and adjustment

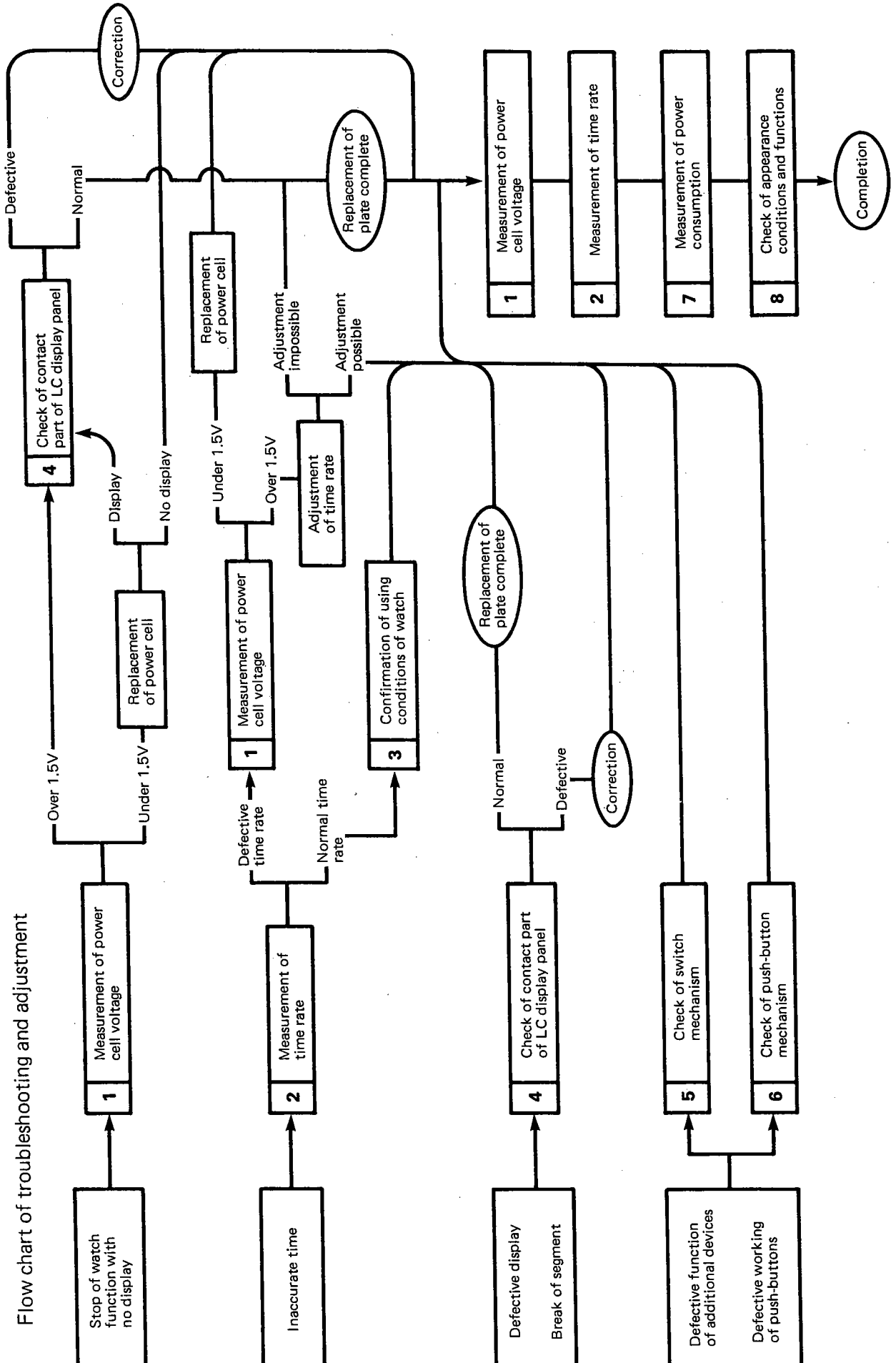

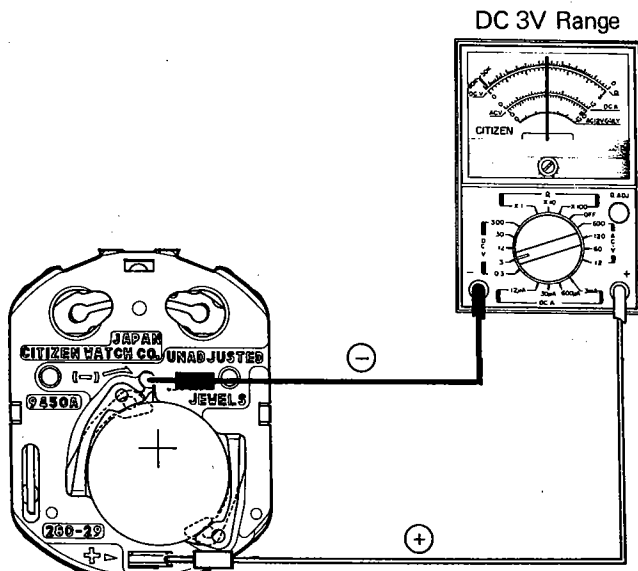
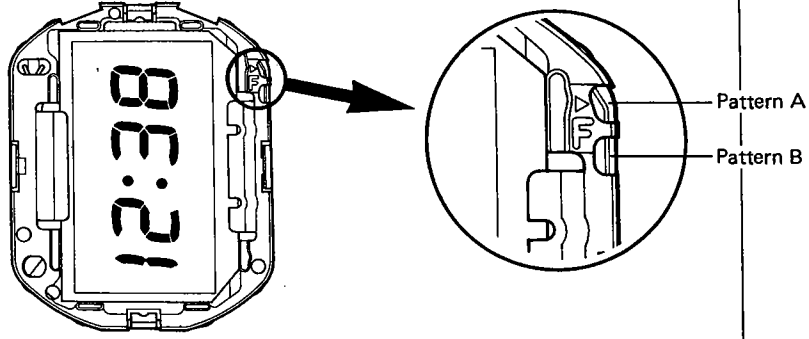
Checking items	How to check	Result and treatment								
<p>1 Measurement of power cell voltage</p>	<p>As shown in the figure, the probes of the tester are applied to the areas of measurement of the movement. The minus area of measurement is the power cell connector spring which looks in the gold color. And the supporter for plate complete functions as VDD. Thus avoid giving a short between them.</p> 	<p>Over 1.5V → Normal</p> <p>Under 1.5V → Replacement of power cell</p>								
<p>2 Measurement of time rate</p>	<p>This watch applies the DFC (Digital Frequency Control) method, and accordingly the unit time of measurement must be set at "10 sec." or its integer-fold value. Otherwise at "2 sec." for example, and accurate measurement is impossible.</p> <p>In case the normal voltage is applied and with some defect detected in the time rate, the following 3-step adjustment is available.</p> <p style="text-align: center;">+15 sec./month, -15 sec./month, -30 sec./month</p> <p>The adjustment is carried out by breaking the patterns (2 areas) of the plate complete which are seen at the notch area of the LC display panel supporter. (The break of the pattern can be done easily with a knife or the like.)</p> <table border="1" data-bbox="747 1428 1234 1596"> <thead> <tr> <th>Break of patter</th> <th>Change of time rate</th> </tr> </thead> <tbody> <tr> <td>Only A</td> <td>+15 sec./month</td> </tr> <tr> <td>Only B</td> <td>-15 sec./month</td> </tr> <tr> <td>A & B</td> <td>-30 sec./month</td> </tr> </tbody> </table>  <p style="text-align: center;">The actual adjustment is carried out as next page.</p>	Break of patter	Change of time rate	Only A	+15 sec./month	Only B	-15 sec./month	A & B	-30 sec./month	
Break of patter	Change of time rate									
Only A	+15 sec./month									
Only B	-15 sec./month									
A & B	-30 sec./month									

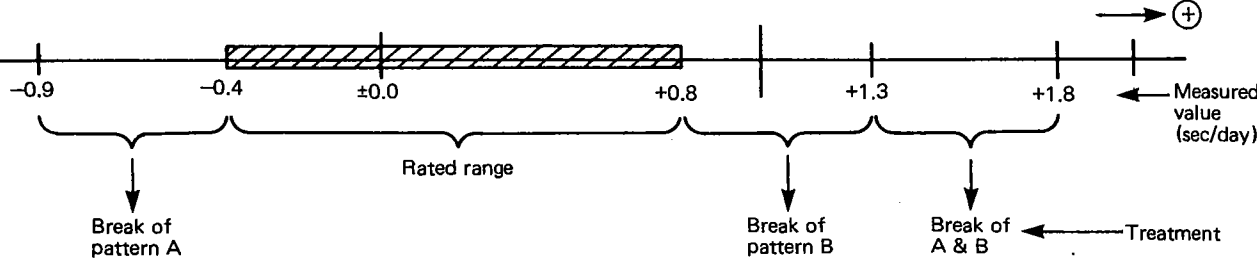
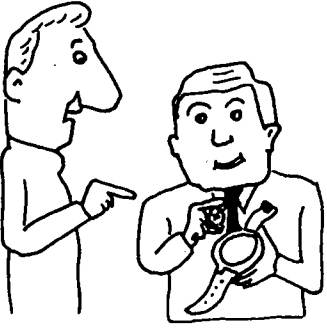
Checking items	How to check	Result and treatment
	 <p data-bbox="479 682 1177 808"> The break of the pattern itself is easy but must be carried out meticulously because the mistaken break is impossible to mend. If a big error is detected in the time rate, the plate complete must be replaced with new one. </p>	
<p data-bbox="219 1050 251 1081">3</p>	<p data-bbox="479 1060 1177 1113">The using condition of the watch is confirmed with its user about the following points.</p> <ol data-bbox="479 1123 1112 1239" style="list-style-type: none"> 1) Handling mistake of the watch. 2) Use of the watch outside its effective temperature range. 3) The time of days elapsed since the last setting of time. 4) Others 	

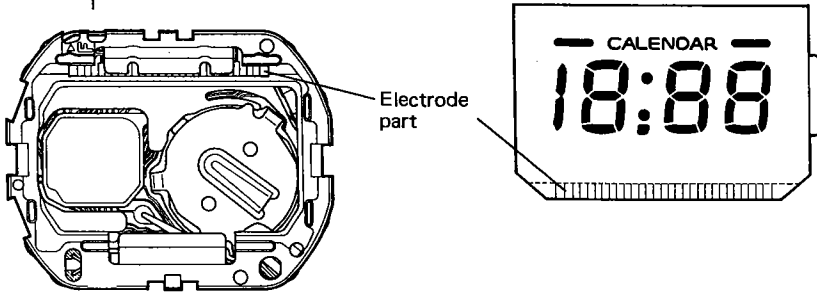
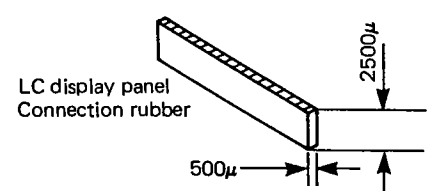
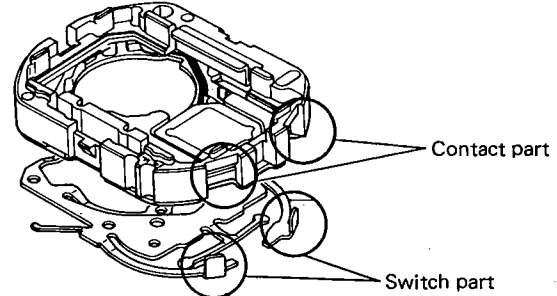
Checking items	How to check	Result and treatment
<p>4 Check of contact part of LC display panel</p>	<ul style="list-style-type: none"> • Make sure that the electrode part of the LC display panel is completely free from break or crack, the dust, the stains or the like. • Make sure that the electrode part of the plate complete is completely free from the dust and stains, or the exfoliation of the pattern and other defects. • Make sure that the LC display connection rubber is free from any malformation such as the twist or wear, the dust or stains and others. • Make sure that a correct and complete assembly is given among the LC display panel, the LC display connection rubber and the plate complete (LC display panel supporter) each.   <p>*The LC display panel connection rubber of this watch has a cross section of 500 x 2500μ. A particular attention must be given to the malformation such as the twist or the like.</p>	
<p>5 Check of switch mechanism</p>	<ul style="list-style-type: none"> • Make sure that the supporter for plate complete is set in an accurate way. • Make sure that a correct and complete contact is secured between the switch part of the supporter for plate complete and the contact part of the plate completed. <p>And the defect if detected through the above two inspections must be mended and settled.</p> 	

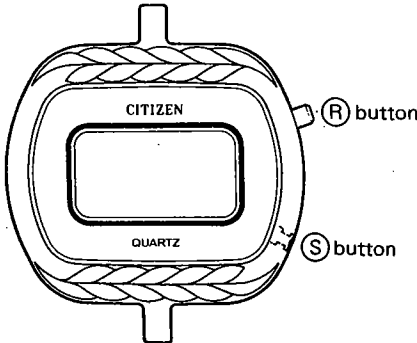
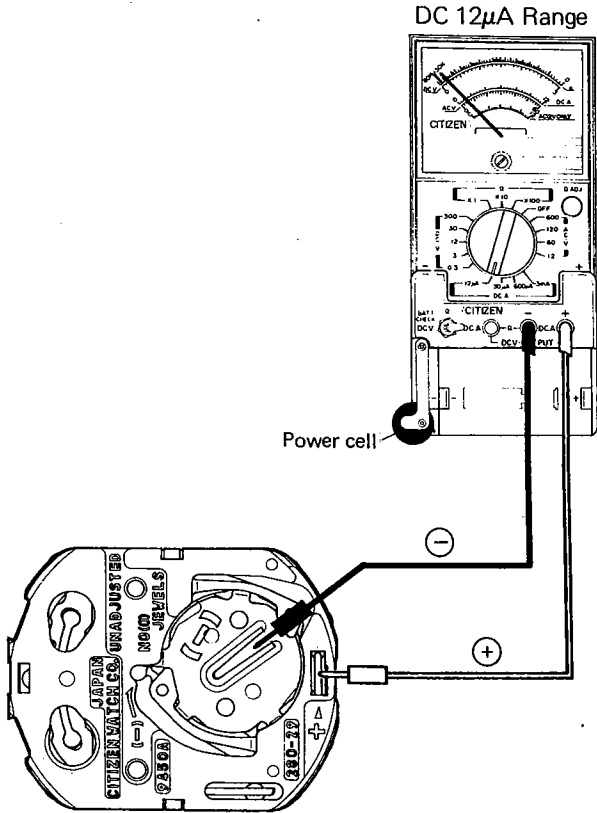
Checking items	How to check	Result and treatment
<p>6 Check of switch-button mechanism</p>	<ul style="list-style-type: none"> • Make sure that the case and the push-buttons are free from any malformation, soils and the like defects. (The silicone oil is applied to the push-buttons each.) • In case the switch stroke has some trouble, an inspection must be given not only to the push-button mechanism but to the mechanism of the supporter for plate complete.  <p>The diagram shows the back of a Citizen Quartz watch case. It features a rectangular window with 'CITIZEN' at the top and 'QUARTZ' at the bottom. On the right side, there are two push-buttons: the upper one is labeled '(R) button' and the lower one is labeled '(S) button'.</p>	
<p>7 Measurement of power consumption</p>	<p>The range of measurement is set at DC12μA, and the points of measurement are shown in the diagram.</p>  <p>The diagram illustrates the setup for measuring power consumption. A multimeter is shown with its dial set to the 'DC 12μA Range'. The multimeter is connected to a 'Power cell' and the back of a watch case. The watch case back is labeled with 'JAPAN', 'CITIZEN WATCH CO. UNADJUSTED', '1000 JEWELS', 'CITIZEN', and '28010'. The multimeter's red probe is connected to the positive terminal (+) and the black probe to the negative terminal (-) of the power cell. The watch case back has a '+' sign and a '-' sign indicating the measurement points.</p>	<p>[Under normal state] Under 1.5μA → Normal</p> <p>[LC display panel removed] Under 1.3μA → Normal</p>

Checking items	How to check	Result and treatment
<p>8 Check of appearance conditions and functions</p>	<p>The following points are confirmed with a finished watch.</p> <ul style="list-style-type: none"> • The display is completely nondefective. • The operation of the push-buttons is correct and smooth. • The LC display screen is completely free from the dust or stains. <div style="text-align: center;">  </div> <p>*All contents of display glow up with a simultaneous push of both (R) and (S) buttons.</p>	

CITIZEN WATCH CO., LTD.
Tokyo, Japan